

User's Manual



Handheld Digital Precision Manometer

GMH 3161-...

Version 6.5



WEEE-Reg.-Nr. DE 93889386

CONTENTS

1	GENERAL NOTE	3
2	SAFETY	3
2.1	INTENDED USE	3
2.2	SAFETY SIGNS AND SYMBOLS	3
2.3	SAFETY GUIDELINES	3
3	PRODUCT SPECIFICATION	4
3.1	SCOPE OF SUPPLY	4
3.2	OPERATION AND MAINTENANCE ADVICE	4
4	HANDLING	5
4.1	DISPLAY	5
4.2	BASIC OPERATION	5
4.3	CONNECTIONS	6
4.4	POP-UP CLIP	6
5	START OPERATION	7
6	CONFIGURATION	7
7	REMARKS TO SPECIAL FEATURES	8
7.1	SEA LEVEL CORRECTION (<i>ONLY FOR GMH 3161-12</i>)	8
7.2	POWER OFF TIME	8
8	OUTPUT	8
8.1	SERIAL INTERFACE	8
9	INPUT ADJUSTMENT	9
9.1	ZERO DISPLACEMENT SENSOR ('OFFS')	9
9.2	SCALE CORRECTION SENSOR ('SCAL')	9
9.3	CALIBRATION SERVICES	9
10	PRESSURE CONNECTION	9
10.1	DEVICE TYPE WITH ABSOLUTE PRESSURE (GMH 3161-12)	9
10.2	DEVICE TYPE WITH RELATIVE PRESSURE	9
11	ERROR AND SYSTEM MESSAGES	10
12	SPECIFICATION	11
13	RESHIPMENT AND DISPOSAL	12
13.1	RESHIPMENT	12
13.2	DISPOSAL INSTRUCTIONS	12

1 General Note

Read this document carefully and get used to the operation of the device before you use it. Keep this document within easy reach near the device for consulting in case of doubt.

Mounting, start-up, operating, maintenance and removing from operation must be done by qualified, specially trained staff that have carefully read and understood this manual before starting any work.

The manufacturer will assume no liability or warranty in case of usage for other purpose than the intended one, ignoring this manual, operating by unqualified staff as well as unauthorized modifications to the device. The manufacturer is not liable for any costs or damages incurred at the user or third parties because of the usage or application of this device, in particular in case of improper use of the device, misuse or malfunction of the connection or of the device.

The manufacturer is not liable for misprints.

2 Safety

2.1 Intended Use

The safety requirements (see below) have to be observed.

The device must be used only according to its intended purpose and under suitable conditions.

Use the device carefully and according to its technical data (do not throw it, strike it, ...)

Protect the device from dirt.

2.2 Safety signs and symbols

Warnings are labeled in this document with the followings signs:



Caution! This symbol warns of imminent danger, death, serious injuries and significant damage to property at non-observance.



Attention! This symbol warns of possible dangers or dangerous situations which can provoke damage to the device or environment at non-observance.







Note! This symbol point out processes which can indirectly influence operation or provoke unforeseen reactions at non-observance.

2.3 Safety guidelines

This device has been designed and tested in accordance with the safety regulations for electronic devices. However, its trouble-free operation and reliability cannot be guaranteed unless the standard safety measures and special safety advises given in this manual will be adhered to when using the device.

1. Trouble-free operation and reliability of the device can only be guaranteed if the device is not subjected to any other climatic conditions than those stated under "Specification".
If the device is transported from a cold to a warm environment condensation may cause in a failure of the function. In such a case make sure the device temperature has adjusted to the ambient temperature before trying a new start-up.

2.  If there is a risk whatsoever involved in running it, the device has to be switched off immediately and to be marked accordingly to avoid re-starting. Operator safety may be a risk if:
- there is visible damage to the device
 - the device is not working as specified
 - the device has been stored under unsuitable conditions for a longer time.
- In case of doubt, please return device to manufacturer for repair or maintenance.
3. When connecting the device to other devices the connection has to be designed most thoroughly as internal connections in third-party devices (e.g. connection GND with protective earth) may lead to undesired voltage potentials that can lead to malfunctions or destroying of the device and the connected devices.
-  This device must not be run with a defective or damaged power supply unit. Danger to life due to electrical shock!
4.  Do not use these products as safety or emergency stop devices or in any other application where failure of the product could result in personal injury or material damage. Failure to comply with these instructions could result in death or serious injury and material damage.
5.  This device must not be used at potentially explosive areas! The usage of this device at potentially explosive areas increases danger of deflagration, explosion or fire due to sparking.

3 Product Specification

3.1 Scope of supply

The scope of supply includes:

- Measuring device with 9V battery
- Operation manual

3.2 Operation and maintenance advice

1. Battery operation:

If 'bAt' is shown in the lower display the battery has been used up and needs to be replaced. However, the device will operate correctly for a certain time. If 'bAt' is shown in the upper display the voltage is too low to operate the device; the battery has been completely used up.



The battery has to be taken out, when storing device above 50 °C.

We recommend taking out battery if device is not used for a longer period of time.

After recommissioning the real-time clock has to be set again.

2. Mains operation with power supply



When using a power supply please note that operating voltage has to be 10.5 to 12 V DC.

Do not apply overvoltage!! Cheap 12V-power supplies often have excessive no-load voltage.

We, therefore, recommend using regulated voltage power supplies.

Trouble-free operation is guaranteed by our power supply GNG10/3000.

Prior to connecting the power supply to the mains make sure that the operating voltage stated at the power supply is identical to the mains voltage.

3. Treat device and sensor carefully. Use only in accordance with above specification. (do not throw, hit against etc.). Protect plug and socket from soiling.

4 Handling

4.1 Display

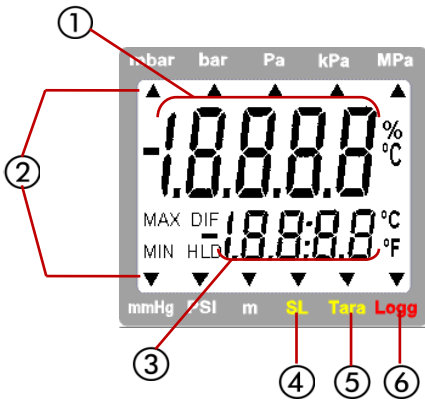

- 1 **Main display:** shows actual value

- 2 Arrow points to the chosen measuring **unit**

- 3 **Secondary display:** shows min./max. or hold value

- 4 **SL:** appears if sea-level-correction is activated
(only GMH 3161-12)

- 5 **Tara:** appears if tara-function is activated

- 6 *Not used*

4.2 Basic Operation

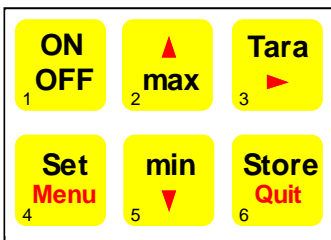

On / Off



min/max bei Messung:

press short: shows the min./max. value

+

press again: hides min./max. value



press 2 sec.: clears particular value

Tara, zero-point adjustment:

press short: display will be set to 0



The following measuring will be relatively displayed to the set tara value

press 2 sec.: deactivates tara-function

press 5 sec.: Zero-Point Adjustment¹⁾



Set/Menu:

press short: invokes configuration menu

Store/Quit:



press short: hold-function, the last measuring value will be held in the secondary display.

press again: hides the value

Please Note: Activating/deactivating tara clears the max- & min-memories.

¹⁾ **Zero-Point Adjustment:** If there is no pressure or zero-pressure (absolute) applied to the pressure ports the device will display 0. If there is a permanent deviation (and device is operated under steady conditions), a permanent zero point adjustment can be carried out. To carry out the adjustment press button 3 for approx. 5 seconds (Auto Null will be displayed shortly). The adjustment is done via the OFFSET-value of the sensor (referring configuration menu).
To recall the manufacturer's calibration press button 3 for approx. 15 seconds.

Please note: - A zero-point adjustment can only be carried out if the difference between the value on display is less than 500 digits!
- If a zero point adjustment was carried out the display shows "Corr" after a restart .

4.3 Connections

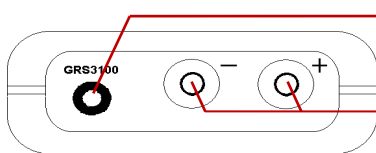

Interface: Connection for el. Isolated interface adapter (please refer to chapter 8.1)

Connection for pressure tubes:

„+“ higher pressure (non-existent at GMH 3161-12)

„-“ lower pressure (GMH 3161-12: absolute pressure)

Power supply: the mains adapter socket is located at the left side of the device.

4.4 Pop-up clip

Handling:

- Pull at label “open” in order to swing open the pop-up clip.
- Pull at label “open” again to swing open the pop-up clip further.

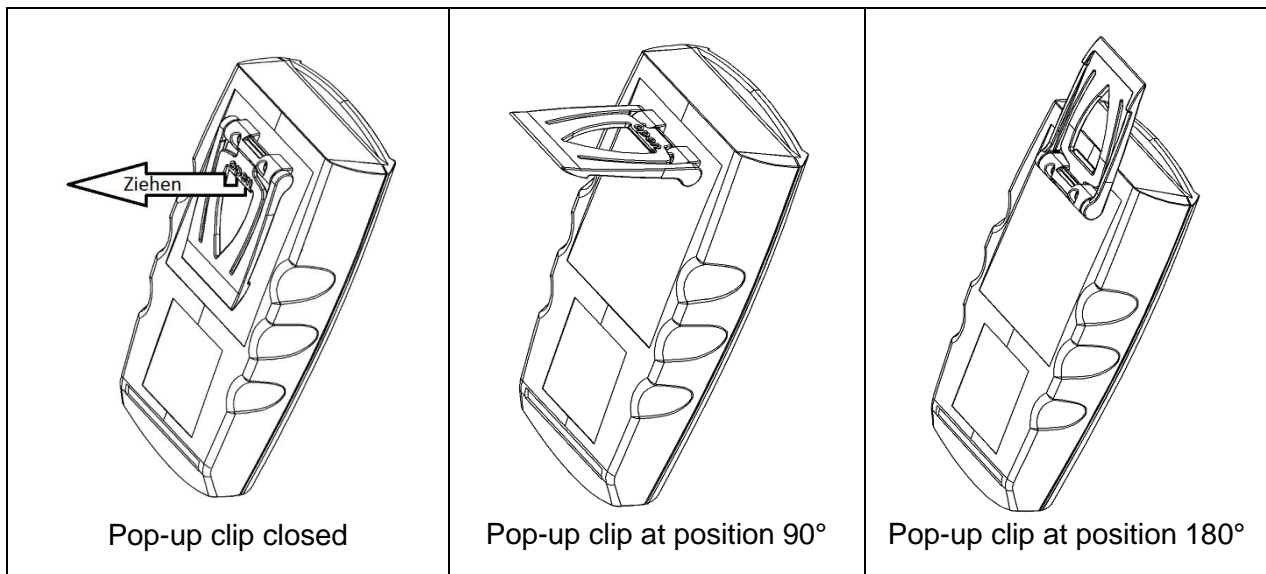

Function:

- The device with a closed pop-up clip can be plainly laid onto a table or attached to a belt, etc.
- The device with pop-up clip at position 90° can be set up on a table, etc.
- The device with pop-up clip at position 180° can be suspended from a screw or the magnetic holder GMH 1300.

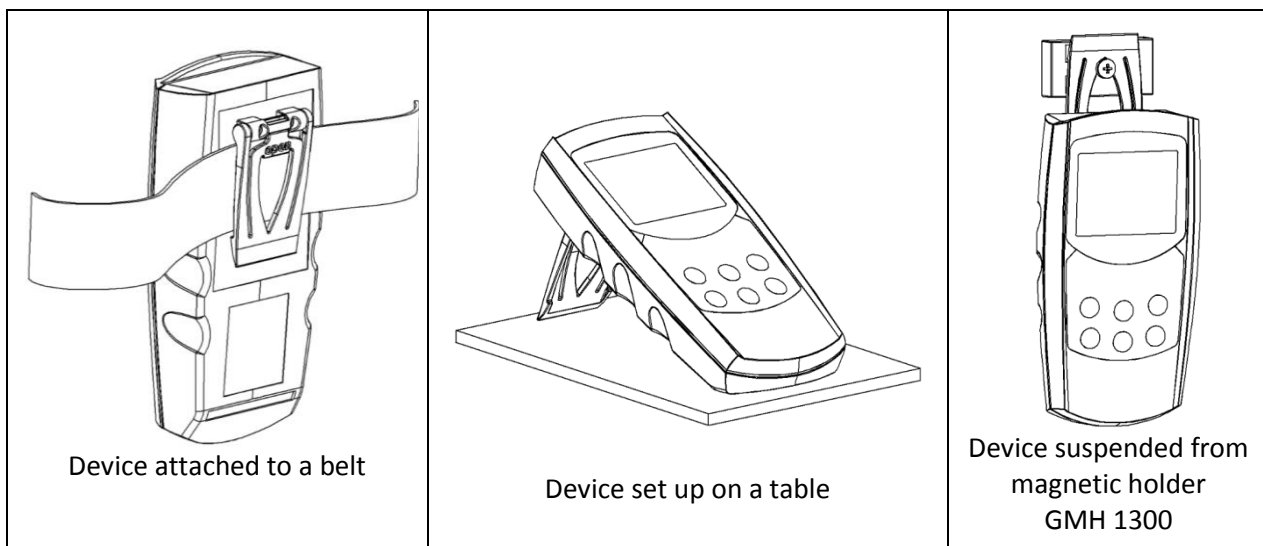

5 Start Operation

Connect sensor, turn on device via  key.



After segment test the device displays some configuration:

- If a **zero point adjustment** was carried out the display shows shortly „nuLL Corr“.

After that the device is ready for measuring.





6 Configuration

To change device settings, press **Menu** (key 4) for 2 seconds. This will call the configuration menu.

Pressing key **Menu** jumps between the parameters.

The parameters can be changed with **▲** (key 2) or **▼** (key 5).

Quit (key 6) finishes the configuration and returns to standard measuring operation.

Parameter	Value	Description
„Menu“	▲ or ▼	
	mbar, bar, ...	Unit: Unit of display
	oFF/on	Sea level correction: on or off <i>(only available at GMH 3161-12)</i>
	-2000 ... 9999	Altitude: Input of altitude above sea level [m] (only if SL=on) <i>(only available at GMH 3161-12)</i>
	1 ... 120	Auto Power Off time in minutes
	oFF	Auto Power Off deactivated
	01, 11 ... 91	Base address of interface
OFFS	<i>refer to list below</i>	The offset of sensor will be displaced by this value to compensate for deviations in the probe or in the measuring device.
	oFF	Zero displacement inactive (=0.00)
SCAL	-2.000 ... 2.000	The measuring scale of sensor will be changed by this factor [%] to compensate deviations of temperature probe or measuring device
	oFF	Scale correction factor inactive (=0.000)

Device type	adjustable offset
GMH 3161-002	-50.0 ... 50.0 Pa
GMH 3161-01	-5.00 ... 5.00 mbar
GMH 3161-07	-50.0 ... 50.0 mbar
GMH 3161-07B	-50.0 ... 50.0 mbar
GMH 3161-07H	-5.00 ... 5.00 mbar
GMH 3161-13	-500 ... 500 mbar
GMH 3161-12	-500 ... 500 mbar

7 Remarks To Special Features

7.1 Sea Level Correction (*only for GMH 3161-12*)

The device displays the absolute pressure measured at the sensor. This is not necessarily the same like the values given by weather stations! The weather stations' values are giving the pressure at sea level. Usually the sensor is placed above sea level and therefore, if the value at sea level(zero) is to be measured, the pressure loss resulting from the actual level above sea level has to be considered! To correct the measuring display activate the „Sea-Level-Function“ (SL, p.r.t. chapter 6). Then enter the altitude above sea level of the sensor's location in meters (Alti, p.r.t. chapter 6). When activated, the display shows the SL-arrow and the device displays the pressure value at sea level.

7.2 Power off Time

If there won't be pressed any key and no interface communication takes place for the time of the power off time setting (P.Off), the device will be switched off automatically to save battery power.

If P.oFF = oFF then the automatic switch off is deactivated.

8 Output

8.1 Serial Interface

By means of the serial interface and a suitable electrically isolated interface adapter (USB 3100, USB 3100 N, GRS 3100 or GRS 3105) the device can be connected to a computer for data transfer.

With the GRS 3105 up to 5 devices of the GMH3xxx- series can be connected to one interface (see also manual of GRS 3105). As a precondition the base addresses of all devices must not be identical, make sure to configure the base addresses accordingly (refer menu point "Adr." in chapter 6).

To avoid transmission errors, there are several security checks implemented e.g. CRC.

The following standard software packages are available:

- **GMHKonfig:** Software for a comfortable editing of the device (e.g. Material selection...)
- **EBS 20M / 60M:** 20-/60-channel software to display the measuring values

In case you want to develop your own software we offer a **GMH3000-development package** including:

- a universally applicable Windows functions library ('GMH3000.DLL') with documentation that can be used by the most programming languages. Suitable for Windows XP™, Windows Vista™, Windows 7™
- Programming examples Visual Basic 4.0™, Delphi 1.0™, Testpoint™

Note: *The measuring and display range values read back from the interface are always in the selected measurement unit (mbar, bar...)!*

Supported functions:

Code	Name/Function	Code	Name/Function
0	Read measurement value	200	Read min display range
3	Read system state	201	Read max display range
6	Read min memory	202	Read display range - unit
7	Read max memory	204	Read display range – decimal point
12	Read ID number	208	Read # of channels
32	Read configuration flag BitCorrectToSealevel:32 (<i>only available at GMH 3161-12</i>)	214	Read scale adjustment [%]
		216	Read offset adjustment
		220	Read altitude (<i>only available at GMH 3161-12</i>)
160	Set configuration flag (see above)	221	Set altitude (<i>only available at GMH 3161-12</i>)
174	Clear min memory	222	Read power off time (Conf-P.oFF)
175	Clear max memory	223	Set power off time (Conf-P.oFF)
176	Read min measuring range	240	Reset
177	Read max measuring range	254	Program version
178	Read measuring range – measuring unit		
179	Read measuring range – decimal point		
180	Read kind of measuring of sensor		
199	Read kind of measuring of display		

9 Input Adjustment

9.1 Zero Displacement Sensor ('OFFS')

A zero displacement can be carried out for the measured value:

$$\text{value displayed} = \text{value measured} - \text{offset}$$

Standard setting: 'off' = 0.0°, i.e. no zero displacement will be carried out. Together with the scale correction (see below) this factor is mainly used to compensate for sensor deviations. Input is in the display unit.

9.2 Scale Correction Sensor ('SCAL')

The scale of the measuring can be influenced by this setting (factor is in %):

$$\text{displayed value} = \text{measured value} * (1 + \text{Scal}/100)$$

Standard setting: 'off' = 0.000, i.e. value is not corrected. Together with the zero displacement (see above) this factor is mainly used to compensate for sensor deviations.

9.3 Calibration Services

Calibration certificates – DKD-certificates – other certificates:

If device should be certificated for its accuracy, it is the best solution to return it to the manufacturer.

Only the manufacturer is capable to do efficient recalibration if necessary to get results of highest accuracy!

10 Pressure Connection

2 (or 1) universal pressure connector for 6 x 1 mm (4 mm tube inner diameter) or 8 x 1 mm (6 mm tube inner diameter) plastic tubes.

10.1 Device type with absolute pressure (GMH 3161-12)

Connect plastic tube to pressure port

10.2 Device type with relative pressure

- **For measurements of overpressure** (refer to summary):

Connect plastic tube to pressure port "+".

Port "-" will not be used!

- **For measurements of underpressure** (refer to summary):

Plug the tube to pressure port "-". The measuring range covers then up to max. overpressure range



Note: All values are displayed now as positive values. No minus sign will be shown.

Example: it is possible to measure under pressure down to -25.00 mbar, the display shows then the value 25.00 (no minus sign).



- **For measurements of pressure differences:**

Connect both plastic tubes to pressure port "+" and "-"; make sure to apply higher pressure to port "+".

Measure ranges:

device type	over- or under pressure	under pressure
GMH 3161-002	- 500.0 ... 500.0 Pa	---
GMH 3161-01	- 1.00 ... 25.00 mbar	- 25.00 ... 0.00 mbar
GMH 3161-07	- 10.0 ... 350.0 mbar	- 350.0 ... 0.0 mbar
GMH 3161-07B	- 10.0 ... 420.0 mbar	- 420.0 ... 0.0 mbar
GMH 3161-07H	- 1.00 ... 70.00 mbar	- 70.00 ... 0.00 mbar
GMH 3161-13	- 100 ... 2000 mbar	- 2000 ... 0 mbar
with option: MB -1..2 BAR	- 1000 ... 2000 mbar	

11 Error And System Messages

Display	Meaning	What to do?
	Low battery power, device will only continue operation for a short period of time	Replace battery
	Battery empty	Replace battery
	Mains operation without battery: wrong voltage	Check power supply, replace it when necessary
No display or confused characters, device does not react on keypress	Battery empty	Replace battery
	Mains operation without battery: wrong voltage or polarity	Check power supply, replace it when necessary
	System error	Disconnect battery and power supplies, wait shortly, then reconnect
	Device defective	Return to manufacturer for repair
Err.1	Measured value above allowable range	Check: pressure above max. range? -> measuring value to high
	Sensor defective	Return to manufacturer for repair
Err.2	Measured value below allowable range	Check: pressure below min range? -> measuring value to low
	Sensor defective	Return to manufacturer for repair
Err.4	Value is too low to be displayed, tara is set	Check: display below -2000 (tara?)?
Err.9	Measured value far out of allowable range	Check: pressure not within sensor range?
Err.7	System error	Return to manufacturer for repair

12 Specification

	GMH 3161 - 002	GMH 3161 - 01	GMH 3161 - 07H	GMH 3161 - 07
Measuring ranges: ¹⁾	-500.0 ... 500.0 Pa (-5.000 ... 5.000 mbar)	-1.00 ... 25.00 mbar	-1.00 ... 70.00 mbar	-10.0 ... 350.0 mbar
Overload: ²⁾ (max.)	max. 250 hPa (mbar)	max. 100 mbar	max. 1 bar	max. 1 bar
Resolution:	0.1 Pa (0.001 mbar)	1 Pa (0.01 mbar)	0.01 mbar	0.1 mbar
Accuracy: (typ.)				
Hysteresis and linearity	±0.3 % FS	±0.3 % FS	±0.1 % FS	±0.2 % FS (±0.1 % FS ³⁾)
temp. depending 0 - 50 °C	±0.4 % FS	±0.4 % FS	±0.4 % FS	±0.4 % FS
Available units:	mbar, Pa, kPa, mmHg, PSI, m H ₂ O	mbar, bar, Pa, kPa, mmHg, PSI, m H ₂ O	mbar, bar, Pa, kPa, mmHg, PSI, m H ₂ O	mbar, bar, kPa, MPa, mmHg, PSI, m H ₂ O

	GMH 3161 - 07B	GMH 3161 - 13	GMH 3181 - 13 Option: MB -1..2 BAR	GMH 3161 - 12
Measuring ranges: ¹⁾	-10.0 ... 420.0 mbar (-7.5 ... 315 mmHg)	-100 ... 2000 mbar	-1000 ... 2000 mbar	0 ... 1300 mbar absolut
Overload: ²⁾ (max.)	max. 1 bar	max. 4 bar	max. 4 bar	max. 4 bar abs.
Resolution:	0.1 mbar (0.1 mmHg)	1 mbar	1 mbar	1 mbar
Accuracy: (typ.)				
Hysteresis and linearity	±0.1 % FS	±0.2 % FS (±0.1 % FS ³⁾)	±0.2 % FS (±0.1 % FS ³⁾)	±0.2 % FS (±0.1 % FS ³⁾)
temp. depending 0 - 50 °C	±0.4 % FS	±0.4 % FS	±0.4 % FS	±0.4 % FS
Available units:	mbar, bar, kPa, MPa, mmHg, PSI, m H ₂ O	mbar, bar, kPa, MPa, mmHg, PSI, m H ₂ O	mbar, bar, kPa, MPa, mmHg, PSI, m H ₂ O	mbar, bar, kPa, MPa, mmHg, PSI, m H ₂ O

1) underpressure measurement up to the overpressure measuring range suitable (refer chapter 10.2)

2) without destruction or recalibration of sensor being necessary

3) at OPTION „higher sensor accuracy“

Pressure units:	selectable
Measuring rate:	slow: 4 meas./sec (ConF-Rate = Slow) fast: >1000 meas./sec (ConF-Rate = FASt and P.dEt)
Nominal temperature:	25°C

Sensor:	Piezo-resistive relative pressure sensor integrated in device. Suitable for air and non-corrosive and non-ionizing gases and liquids. (Not suitable for water – use air buffering)
Connection:	2 (1) metal pressure ports for connection to 6 x 1 mm (4 mm inner tube Ø) or 8 x 1 mm (6 mm inner tube Ø) tubes at the top of device
Display:	2 four digit LCDs (12.4 mm high and 7 mm high) for measuring values, and for min/max memories, hold function, etc. as well as additional functional arrows.
Pushbuttons:	6 membrane keys
Output:	3.5 mm audio plug, stereo
Interface:	Serial interface (3.5mm jack) can be connected to USB or RS232 interface of a PC via electrically isolated interface adapter USB 3100, USB 3100 N, GRS 3100 or GRS 3105 (see accessories).
Power supply:	9V battery, type: IEC 6F22 (included in scope of supply) as well as additional d.c. connector (diameter of internal pin 1.9 mm) for external 10.5-12V direct voltage supply. $\ominus \oplus$ (suitable power supply: GNG10/3000)
Power consumption:	~ 0.6 mA
Low battery warning:	' bAt '

Working conditions: -20 ... +50 °C, 0 ... 95 %RH (not condensing)

Storage temperature: -20 ... +70 °C

Housing: impact-resistant ABS, membrane keyboard, transparent panel, Front side IP65
Dimensions: 142 x 71 x 26 mm (L x W x D) + metal pressure ports 11 mm at top of device
Weight: approx. 165 g

EMC: The device corresponds to the essential protection ratings established in the Regulations of the Council for the Approximation of Legislation for the member countries regarding electromagnetic compatibility (2004/108/EG).
Additional fault: <1%

13 Reshipment and Disposal

13.1 Reshipment



GEFAHR

All devices returned to the manufacturer have to be free of any residual of measuring media and other hazardous substances. Measuring residuals at housing or sensor may be a risk for persons or environment



Use an adequate transport package for reshipment, especially for fully functional devices. Please make sure that the device is protected in the package by enough packing materials.

13.2 Disposal instructions



Batteries must not be disposed in the regular domestic waste but at the designated collecting points.



The device must not be disposed in the unsorted municipal waste! Send the device directly to us (sufficiently stamped), if it should be disposed. We will dispose the device appropriate and environmentally sound.